	Document Ref.:	Issue Date:
	CU/WI/MEDIA/07	25 th March, 2013
	Issue No.:	Revision No.:
	02	00
Document Title: WORK INSTRUCTION FOR MEDIA PRACTICAL SESSIONS		

CHUKA UNIVERSITY

WORK INSTRUCTION

FOR

MEDIA PRACTICAL SESSIONS (CU/WI/MEDIA/07)

DOCUMENT REVIEW SHEET

The signatures below certify that this Work Instruction (WI) has been reviewed and accepted, and demonstrate that the signatories are aware of all the requirements contained herein and are committed to ensuring their provision.

Name	Signature	Date
Prepared By: HENRY NKORU NABEA		18.3.2013
Controlled By: HOD		20.3.2013
Approved By: DEAN		25.3.2013

	Document Ref.:	Issue Date:
	CU/WI/MEDIA/07	25th March, 2013
	Issue No.:	Revision No.:
	02	00
Document Title: WORK INSTRUCTION FOR MEDIA PRACTICAL SESSIONS		

CONTENTS

DOCUMENT REVIEW SHEET.....	1
CONTENTS.....	2
1.0 AMENDMENT RECORD SHEET.....	3
2.0 GENERAL.....	4
2.1 Purpose.....	4
2.2 Scope.....	4
2.3 References.....	4
2.4 Definitions and Abbreviations.....	4
2.5 Responsibility.....	4
2.6 Tools and Equipment.....	4
2.7 Safety Requirements.....	5
3.0 INSTRUCTIONS.....	5
3.1 Checking Supplied Items.....	5
3.2 Attach the Lens Hood With Lens Cover.....	6
3.3 Charging the Battery Pack.....	6
3.4 Turning the Power on and Holding Your Camcorder Properly.....	6
3.5 Inserting A Tape or a “Memory Stick Duo”Media.....	7
3.6 Recording/Playback.....	8
3.7 Using the Menu Items.....	9
3.8 Copying Movies on TV or Computer.....	11
4.0 RECORDS.....	11

	Document Ref.:	Issue Date:
	CU/WI/MEDIA/07	25th March, 2013
	Issue No.:	Revision No.:
	02	00
Document Title: WORK INSTRUCTION FOR MEDIA PRACTICAL SESSIONS		

1.0 AMENDMENT RECORD SHEET

DATE	ISSUE NO.	REVISION NO.	PAGE NO.	SUBJECT OF REVIEW /MODIFICATION	REVISED BY	APPROVED BY
18.3.13	02	00	ALL	Changed Chuka University College to Chuka University and inserted a new Logo	Lecturer	Dean
18.3.13	02	00	ALL	Changed CUC to CU	Lecturer	Dean
18.3.13	02	00	ALL	Changed QMR to MR everywhere it existed	Lecturer	Dean
18.3.13	02	00	ALL	Changed Principal to Vice-Chancellor everywhere it existed	Lecturer	Dean
18.3.13	02	00	ALL	Replaced Quality Management Representative with Management Representative all over the footer	Lecturer	Dean

	Document Ref.:	Issue Date:
	CU/WI/MEDIA/07	25th March, 2013
	Issue No.:	Revision No.:
	02	00
Document Title: WORK INSTRUCTION FOR MEDIA PRACTICAL SESSIONS		

2.0 GENERAL

2.1 Purpose

The purpose of this work instruction is to provide guidelines in operating sony digital camcorder DSR-PD 177

2.2 Scope

This WI applies to media and communication studios (Laboratories)

2.3 References

- (i) ISO 9001:2008 Clause 4.2.3, 7.5, 7.6
- (ii) Quality Manual
- (iii) manual for operating DSR-PD 177P sony camcorder.

2.4 Definitions and Abbreviations

Definitions

In addition to the relevant common definitions of terms given in ISO 9000:2005, the following specific definitions shall apply:

Abbreviations

- **AMR:** Assistant Management Representative
- **MR:** Management Representative
- **QMS:** Quality Management System
- **WI:** Work Instruction

2.5 Responsibility

- (i) The HOD has the principal responsibility for ensuring that this procedure remains adequate for its intended purposes.
- (ii) The technologist and the lecturer(s) concerned have the responsibilities of mounting the PD-177P on tripod for use, charging the battery, loading the tape and the memory card, setting the menu and playback.

2.6 Tools and Equipment

The following tools will be required to perform the instructions

- (i) A charged battery (infolithium NP-F570, NP-F770, NP-F970)
- (ii) Min DV cassette /Min Div Cam cassette
- (iii) Memory stick (PRO Duo or PRO-HG Duo)
- (iv) Tripod stand

	Document Ref.:	Issue Date:
	CU/WI/MEDIA/07	25 th March, 2013
	Issue No.:	Revision No.:
	02	00
Document Title: WORK INSTRUCTION FOR MEDIA PRACTICAL SESSIONS		

2.7 Safety Requirements

- (i) Do not connect cables of the camcorder with their terminals placed the wrong way
- (ii) The camcorder is not dust proof or drip proof
- (iii) Do not hold the camcorder on the following parts; lenshood, LCD panel ,Internal Microphone and microphone holder
- (iv) Do not use/ store the camcorder and accessories in the following conditions-,anywhere humid
- (v) Anywhere extremely hot or cold , never leave them exposed to temperatures above 60°C.
- (vi) Near strong magnetic field or mechanical vibration, it may not record properly.
- (vii) Near strong radio waves or radiation.
- (viii) Near AM receivers and radio equipment .
- (ix) On a sandy beach or anywhere dusty.
- (x) Near windows or outdoors where LCD screen, the view finder or the lens may be exposed to direct sunlight .

- (xi) Operate the camcorder on DC 7.2 V battery pack.
- (xii) Do not use deformed or damaged battery.
- (xiii) Do not let the camcorder get wet.
- (xiv) If any solid or liquid gets inside the casing unplug and let it checked by sony dealer.
- (xv) Avoid rough handling disassembling modifying physical shock or impact such as dropping hammering or stepping on.
- (xvi) Do not wrap the camcorder with a towel or clothing heat may build up or clothing –may build up.

- (xvii) keep the power switch to OFF/CHQ when not using the camcorder .
- (xviii) if the battery electrolyte leak consult the authorized sony service facility .
- (xix) keep the remote and battery out of children.

3.0 INSTRUCTIONS

Getting Started

3.1 Checking Supplied Items

Make sure that you have following items supplied with the camcorder.

The number in the parentheses indicates the number of that item supplied.

The cassette tape (mini Dv/Dv Cam) and “Memory Stick Duo” media are not included, AC Adaptor

(1), Power cord (mains lead) (1), Wireless Remote Commander (RMT-831)(1) ,

	Document Ref.:	Issue Date:
	CU/WI/MEDIA/07	25 th March, 2013
	Issue No.:	Revision No.:
	02	00
Document Title: WORK INSTRUCTION FOR MEDIA PRACTICAL SESSIONS		

A button-type lithium battery is already installed, A/V connecting cable (1), Videoaudiocable(1), Large eyecup (1), Lens hood with lens cover(1) This lens hood is pre-mounted.

3.2 Attach the Lens Hood With Lens Cover

Align the marks on the lens hood to those on the camcorder, and turn the lens hood clockwise.

To remove the lens hood with lens Cover turn the lens hood in the opposite direction while pressing the PUSH (lens hood release) button.

To open or close the shutter of the lens hood with lens cover move the lens cover lever to OPEN to open the lens cover, and move the lever to CLOSE to close the lens cover.

3.3 Charging the Battery Pack

- Press the battery pack against the back of your camcorder and slide it down.
- With the B mark on the DC plug facing outwards, connect the DC plug to the DC IN jack on your camcorder.
- Connect the power cord (mains lead) to the AC Adaptor.
- Connect the power cord (mains lead) to the wall outlet (wall socket).
- Set the POWER switch to OFF(CHG).
- The CHG lamp lights up and charging starts.

3.4 Turning the Power on and Holding Your Camcorder Properly

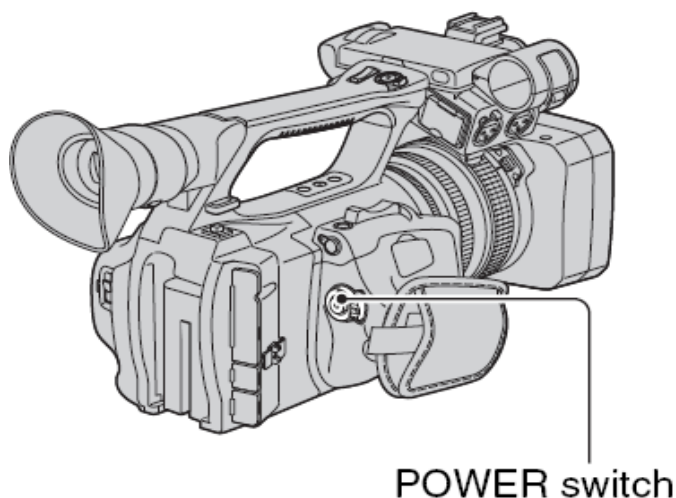

	Document Ref.:	Issue Date:
	CU/WI/MEDIA/07	25 th March, 2013
	Issue No.:	Revision No.:
	02	00
Document Title: WORK INSTRUCTION FOR MEDIA PRACTICAL SESSIONS		

- Slide the POWER switch to CAMERA or VCR while you press the green button.

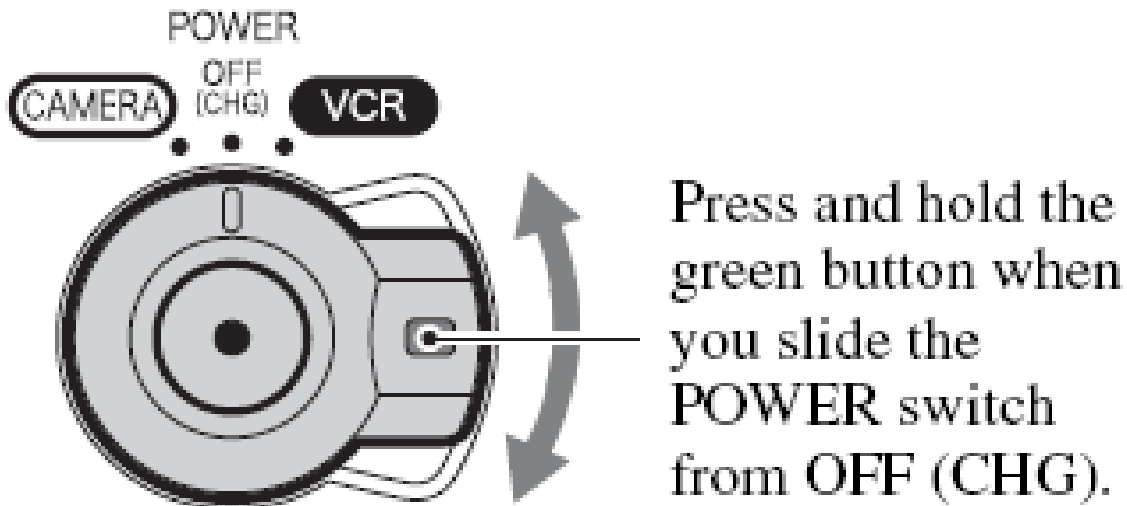

CAMERA: To record pictures.

VCR: To play or edit pictures.

- Hold the camcorder properly.
- Ensure a good grip, then fasten the grip belt.
- To turn off the power, Slide the POWER switch to OFF (CHG) while pressing the green button
- Open the LCD panel 180 degrees (1), then rotate it to the best angle to record or playback
- Adjust the view finder lever . Move it until the picture becomes clear.

3.5 Inserting a Tape or a “Memory Stick Duo” media

- Slide and hold the OPEN/EJECT lever in the direction of the arrow and open the lid.
- The cassette compartment automatically comes out.
- Insert a cassette with its window facing outwards, then press push.
- The cassette compartment automatically slides back in.
- Close the lid.
- To eject the cassette: Open the lid following the same procedure as described in step 1 and remove the cassette.

	Document Ref.:	Issue Date:
	CU/WI/MEDIA/07	25 th March, 2013
	Issue No.:	Revision No.:
	02	00
Document Title: WORK INSTRUCTION FOR MEDIA PRACTICAL SESSIONS		

3.6 Recording/Playback

Recording

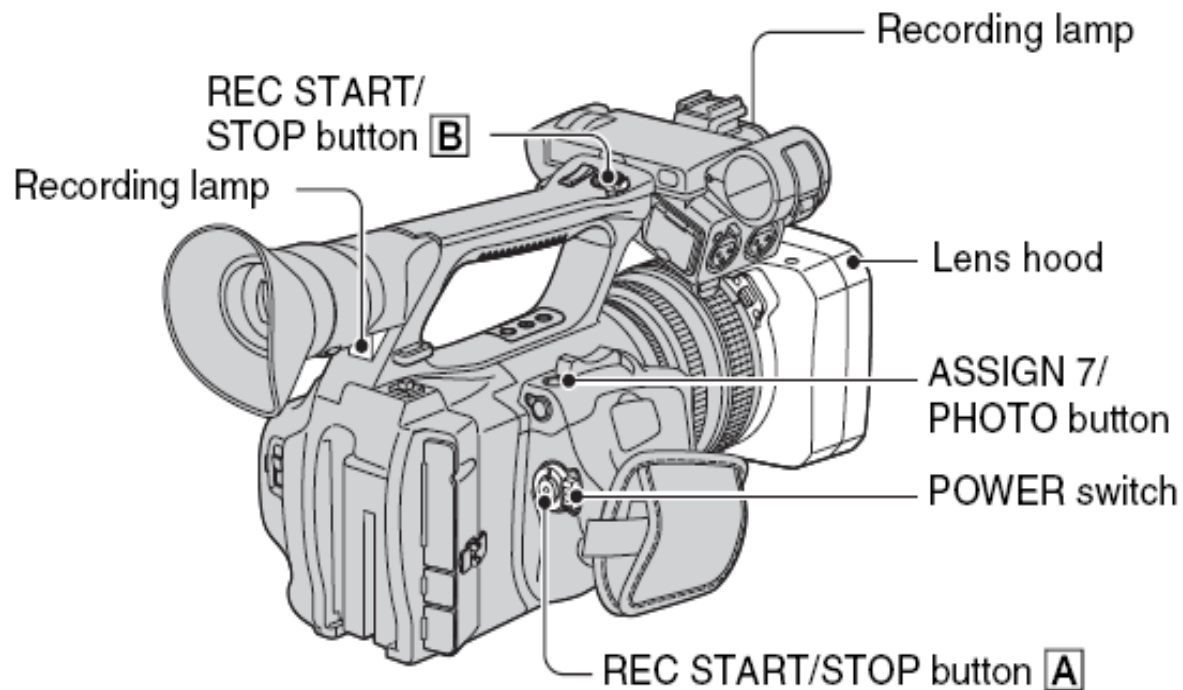

The camcorder records movies on tape minDv/Dvcam and still images on “Memory Stick Duo” media.

Do the following steps to record movies.

- Open the shutter of the lens hood.
- Slide the POWER switch to CAMERA while pressing the green button.
- Press the REC START/STOP button A or B.
- The recording lamp lights up during recording.

	Document Ref.:	Issue Date:
	CU/WI/MEDIA/07	25 th March, 2013
	Issue No.:	Revision No.:
	02	00
Document Title: WORK INSTRUCTION FOR MEDIA PRACTICAL SESSIONS		

Playback

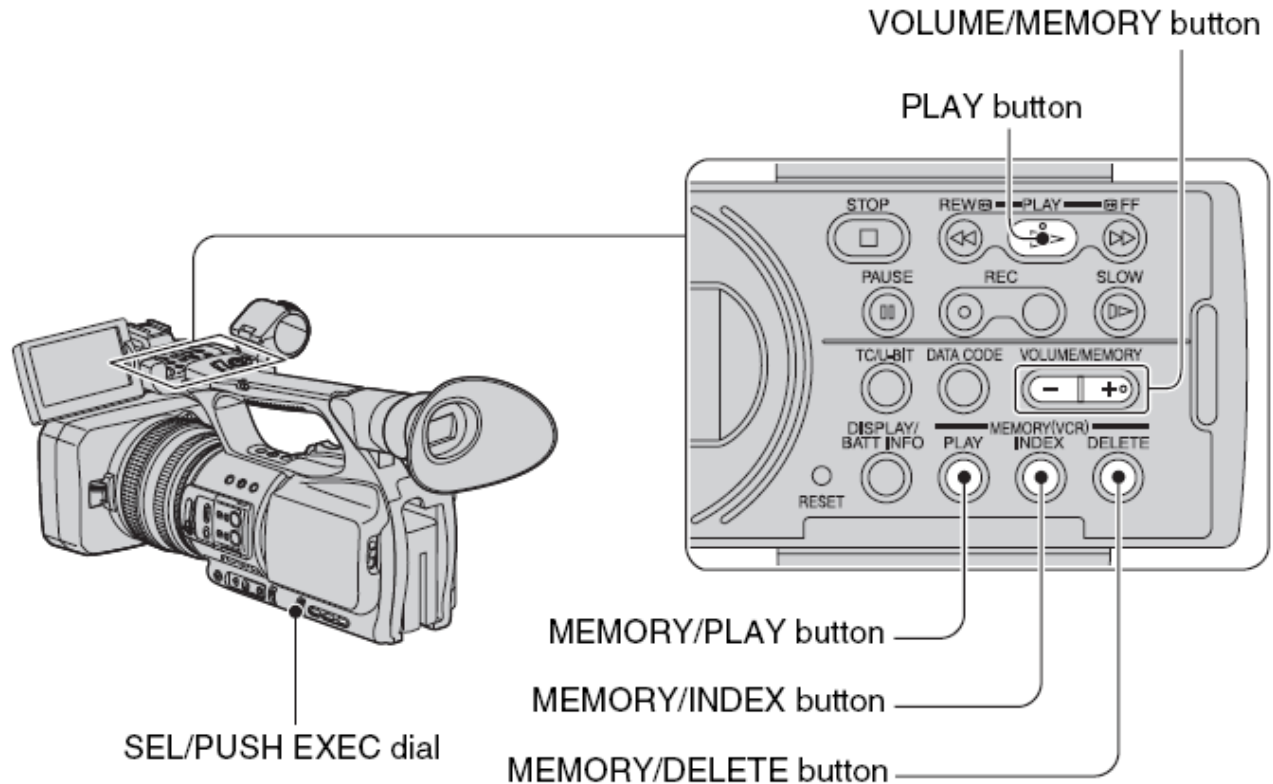

You can play back movies as follows:

- Slide the POWER switch to VCR while pressing the green button.
- Start playing.

Press ◀◀ (rewind) to go to the point you want to view, then press ▶▶ (play) to start playback.

- ■ : STOP
- || : PAUSE (Press ▶▶ or || again to restart the playback)
- ◀◀ : REW ◀◀ (Rewind, review)
- ▶▶ : ▶▶ FF (Cue, fast forward)
- ▶▶ : SLOW

3.7 Using the Menu Items

You can change various settings or make detailed adjustments using the menu items displayed on the screen.

	Document Ref.:	Issue Date:
	CU/WI/MEDIA/07	25 th March, 2013
	Issue No.:	Revision No.:
	02	00
Document Title: WORK INSTRUCTION FOR MEDIA PRACTICAL SESSIONS		

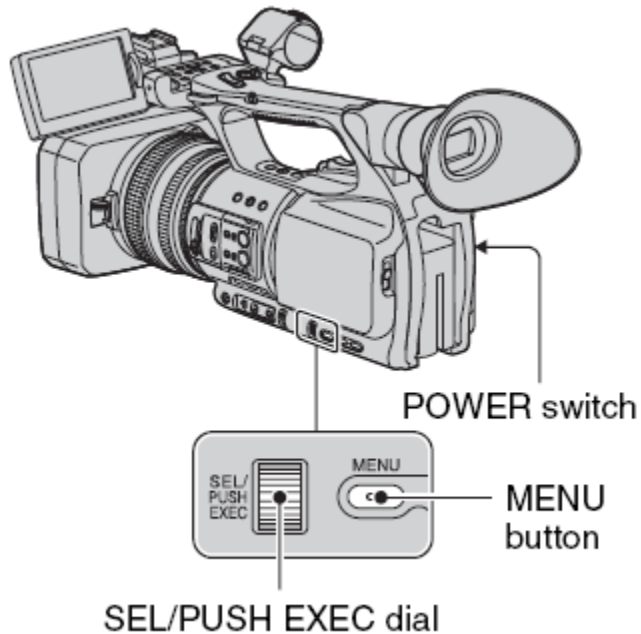

- Set the POWER switch to CAMERA or VCR.
- Press the MENU button.
The menu index screen appears.
- Turn the SEL/PUSH EXEC dial until the icon of the desired menu is highlighted, then press the dial to select the menu.

CAMERA SET
 AUDIO SET
 DISPLAY SET
 IN/OUT REC
 TC/UB SET
 MEMORY SET
 OTHERS

- Turn the SEL/PUSH EXEC dial until the desired menu item is highlighted, then press the dial to select the item.

The available menu items vary depending on the position of the power switch of your camcorder. Unavailable items will be grayed out.

- Turn the SEL/PUSH EXEC dial until the desired setting is highlighted or to bring up the desired setting, then press the dial to confirm the setting.
- Press the MENU button to hide the menu screen.
- To return to the previous screen, select [RETURN]. • To stop movie recording, press the REC START/STOP button again pressing the green button

	Document Ref.:	Issue Date:
	CU/WI/MEDIA/07	25 th March, 2013
	Issue No.:	Revision No.:
	02	00
Document Title: WORK INSTRUCTION FOR MEDIA PRACTICAL SESSIONS		

3.8 Copying Movies on TV or Computer

Connecting camcorder to a TV through a VCR

Connect the camcorder to the LINE IN input on the VCR. Set the input selector on the VCR to LINE (VIDEO 1, VIDEO 2, etc.), if the VCR has an input selector.

Connect the camcorder to a computer with an i.LINK cable. The computer needs to have an i.LINK connector and be installed with editing software.

- Prepare editing software.
- Turn on your computer.
- Insert a tape into your camcorder and set the POWER switch to VCR.
- Copy images to the computer with your software.

4.0 RECORDS

This section is used to identify records

Record ID	Owner	Location	Record Media	Retention/Disposition